



Incorrect installation and connections will make the devices unable to work or may even damage the motherboard. Please observe the instruction in this manual and the motherboard manufacturer. Any loss caused by nonobservance of the instructions in this manual is not covered by the product warranty. The connectors and sockets vary with different motherboards. For detailed instructions, please refer to the instructions in this manual is not covered by the product warranty.

The following are not covered by the warranty:

- The product which has been modified/repared without permission from Cubitek or the bar code sticker has been defaced, modified or removed.
- Damage deterioration or malfunction resulting from any accident calamity.
- Shipping or transport damage by your local courier, or any other cause which does not relate to a product defect.

More detail, please visit [www.cubitek.com](http://www.cubitek.com) for more information about warranty.

錯誤的安裝和連接將會導致裝置無法使用，還有可能導致主板等裝置的損壞。請依照此一及主板的說明書上的指示。所有因不遵守說明書規定的個人錯誤，將不提供保固。端子和連接器的排列可能和主板不同，請詳細地比對主板廠和電源供應器廠所提供的使用說明書。

以下幾點將無法提供保固：

- 產品經過非Cubitek授權的人員，修理或是改裝，產品條碼經過修改或是移除。
- 產品因天災、事故，或是因您的地區代理商所導致的損壞。

是需要更多詳情，請拜訪[www.cubitek.com](http://www.cubitek.com)網站來取得更多訊息。

## Case Internal Structure

## 機殼內部架構

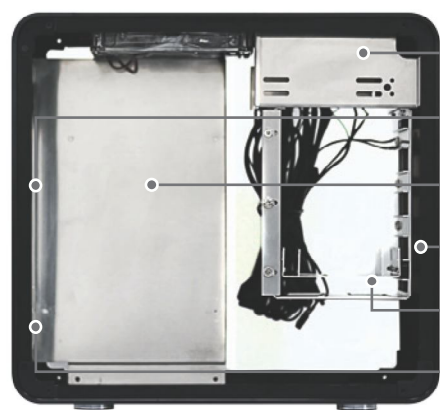

- 5.25" External Device Bay
- PSU
- Motherboard Tray
- 3.5" Internal Device Bay
- 2.5" Internal Device Bay
- PCI Slots

## Hardware List

## 零件盒項目

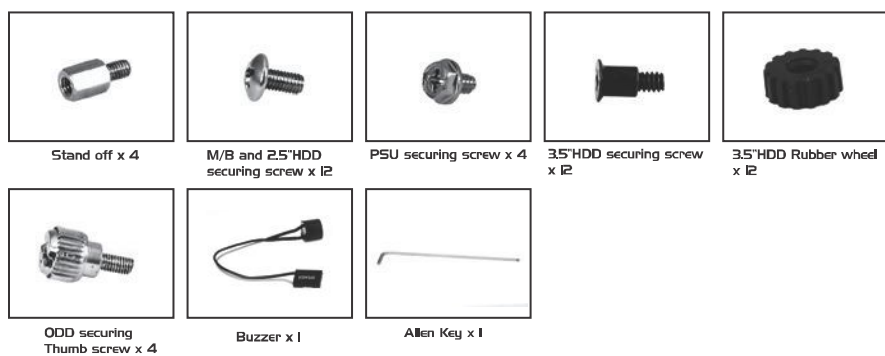

Stand off x 4

M/B and 2.5"HDD securing screw x 12

PSU securing screw x 4

3.5"HDD securing screw x 12

3.5"HDD Rubber wheel x 12

ODD securing Thumb screw x 4

Buzzer x 1

Allen Key x 1

## Cable Kit

## 線材類型

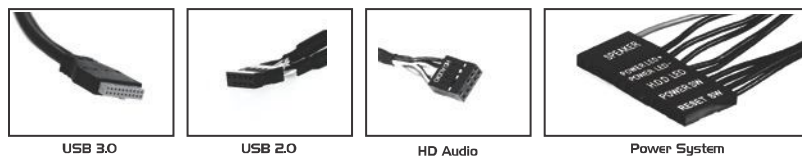

USB 3.0

USB 2.0

HD Audio

Power System

## Removal of Side Panel

## 側板拆卸



## PSU Installation

## 電源安裝

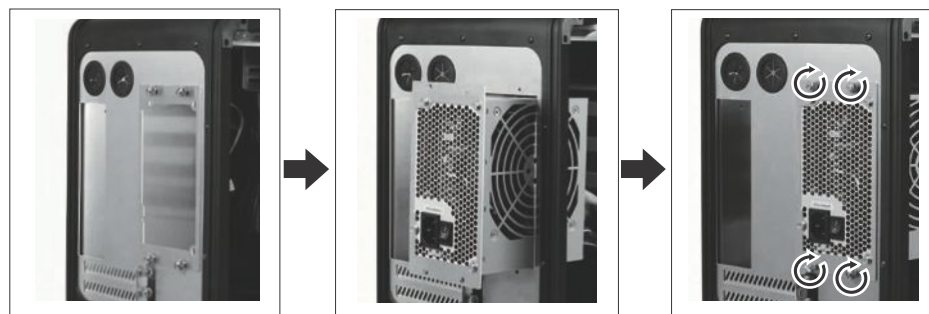

## Motherboard Installation

## 主機板安裝

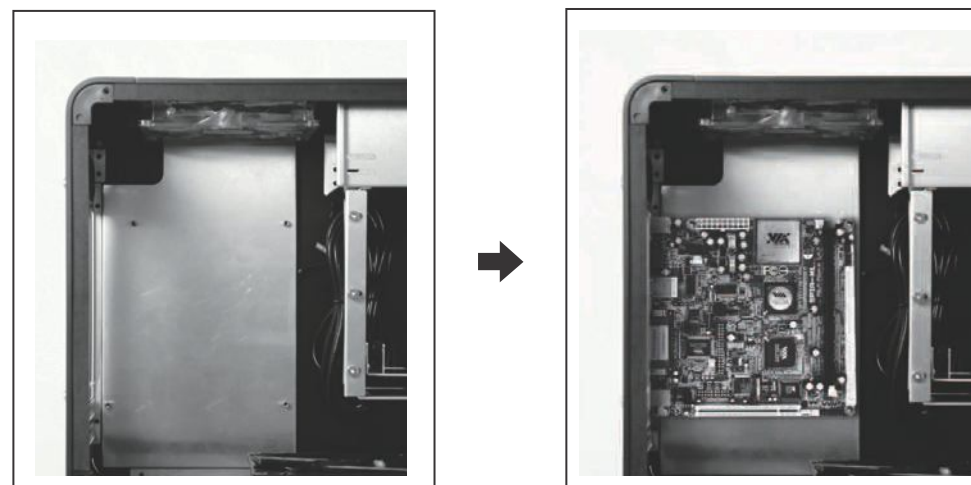

Place the M/B on the stand off.

Place the M/B secure with M3 screws.

## I/O Port Installation

## 多媒體插座接線定義

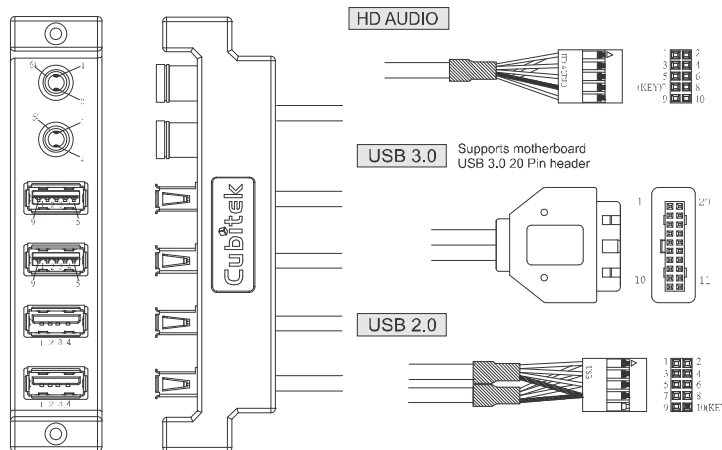

EN HD Audio Connector			
Pin	Definition	Pin	Definition
1	GND	6	Port 2R
2	Port 1	7	No Pin / KEY
3	Presence #	8	Sense_Send
4	Port 1R	9	Sense2_Return
5	Sense 1_Return	10	Port 2L

EN USB 2.0 Connector			
Pin	Definition	Pin	Definition
1	Power	6	Data 2+
2	Power	7	GND
3	Data 1-	8	GND
4	Data 2-	9	No Pin / KEY
5	Data 1+	10	NC

EN USB3.0 Connector			
Pin	Definition	Pin	Definition
1	VBUS	11	D+
2	intA_SSRX-	12	D-
3	intA_SSRX+	13	GND_PWRrt
4	GND_DRAIN	14	intA_SSTX+
5	intA_SSTX-	15	intA_SSTX-
6	intA_SSTX+	16	GND_DRAIN
7	GND_PWRrt	17	intA_SSRX+
8	D-	18	intA_SSRX-
9	D+	19	VBUS
10	No Pin	20	No Pin/KEY

## ODD Installation

## 光碟機安裝



## 3.5" HDD Module Installation

## 3.5" 硬碟安裝

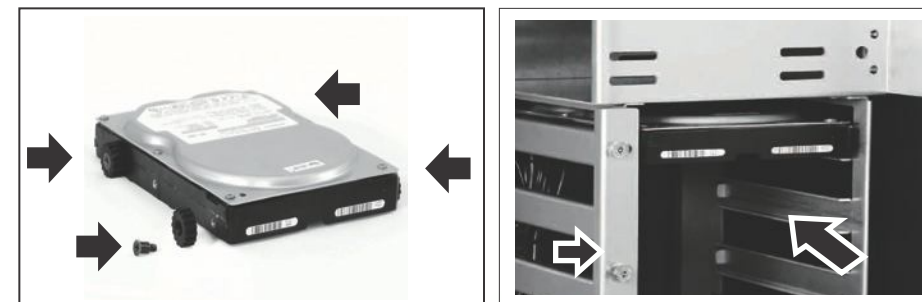

## 2.5" HDD Module Installation

## 2.5" 硬碟安裝

